

(A):

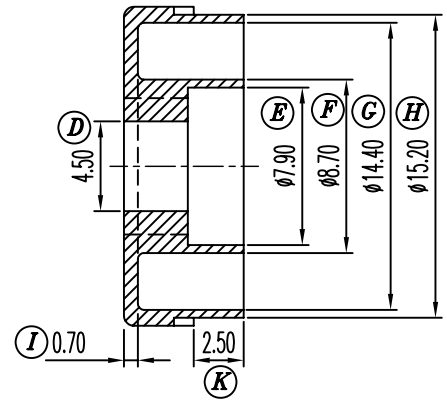

SECTION A-A

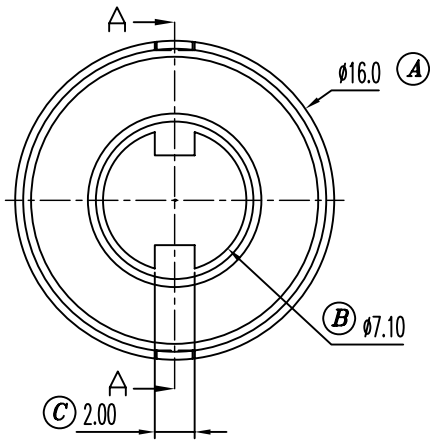
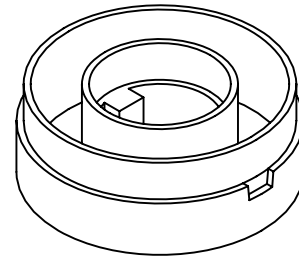
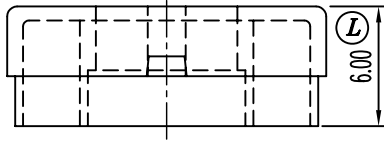

(B):

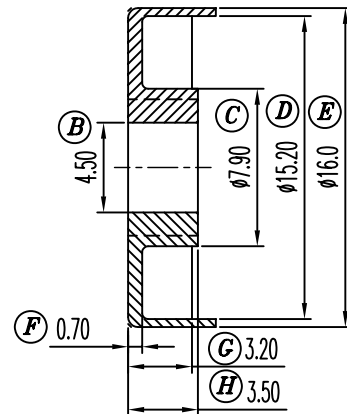
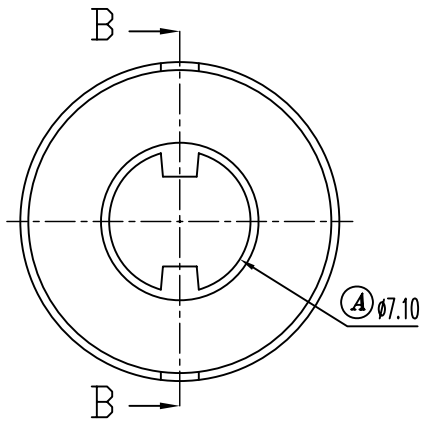

SECTION B-B

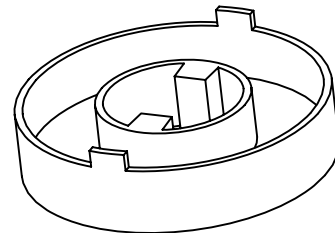
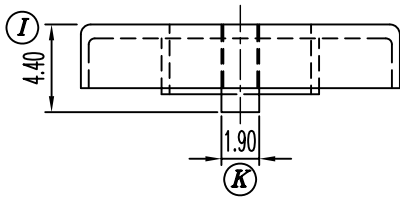

REV.	REVISION RECORD	DATE	REV.	REVISION RECORD	DATE
A			C		
B			D		

NAME	小白殼(14*5*8)	MATERIAL	PBT-4815	SCALE	3/1	ANGLE:	±1°
DRAWING NO.	HY C025	PIN MATERIAL		UNIT	m/m	REV.:	A
TOLERANCE OF PIN PITCH	±0.20			信詠塑膠工業股份有限公司 HSIN YUNG PLASTIC INDUSTRIAL CO., LTD. TEL: 886-2-29953711 FAX: 86-2-29990010 信詠塑膠電子廠 HSIN YUNG PLASTIC ELECTRONICS FACTORY TEL: 0769-6632011 FAX: 0769-6635843			
PIN TENSION LOAD	MIN	UL REC.: 94V-0					
TOLERANCE: 0<L≤4:±0.1 4<L≤16:±0.2 16<L≤63:±0.3							